



**Porsche AG, Taycan (Y1A),
Saloon
from MY 2020**



PORSCHE



Secondary emergency disconnection point

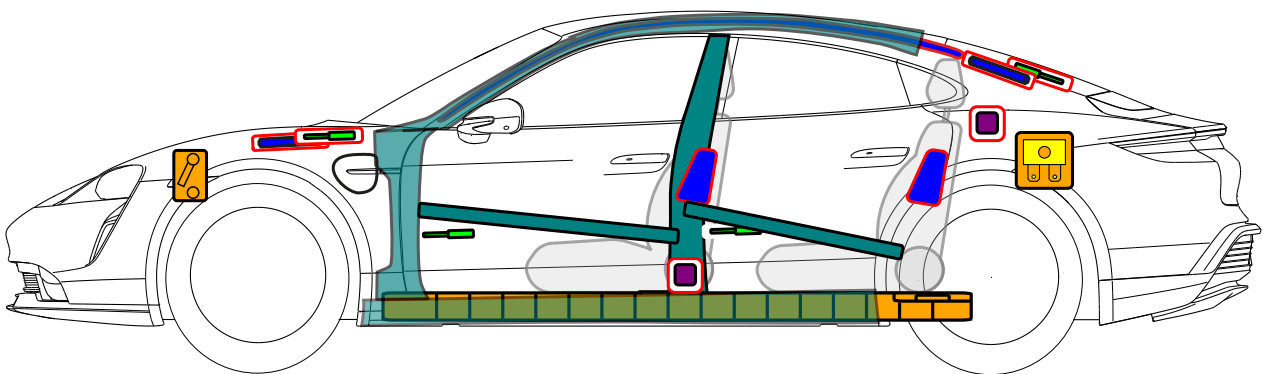
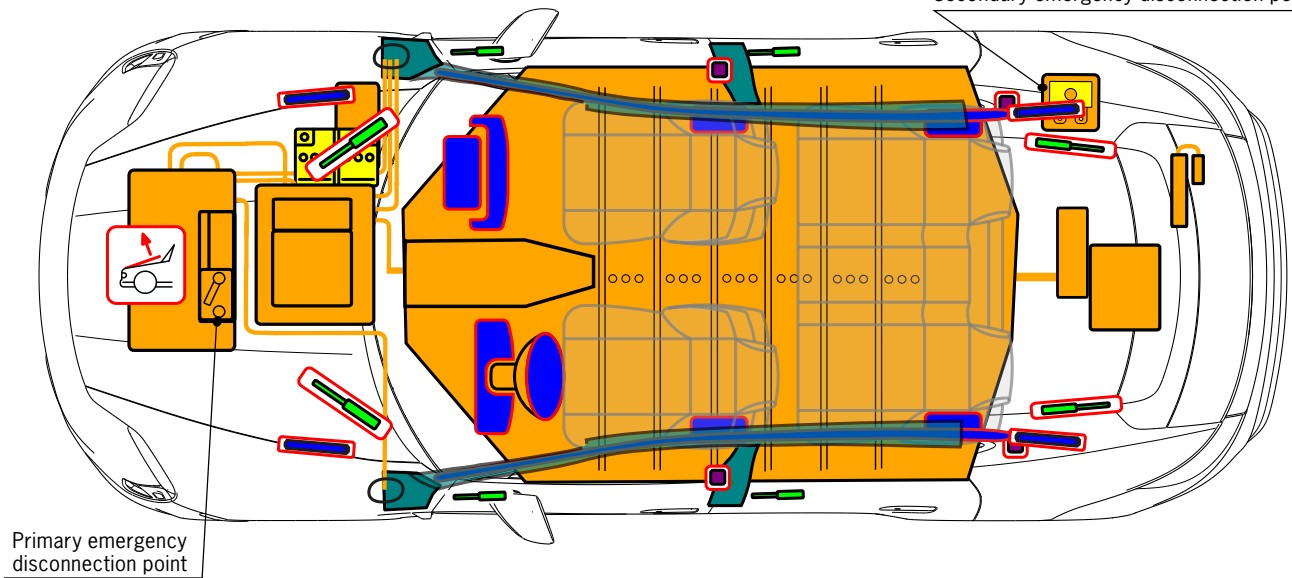

Airbag



Body reinforcement



SRS-Control unit



High voltage battery



Gas generator



Gas strut



12-volt Battery



High voltage cable / component



Seat belt pretensioner



Pedestrian protection system



Fuse box



High voltage cut-off



Fuel tank



Roll-over protection



Condenser

1. Vehicle identification and marking

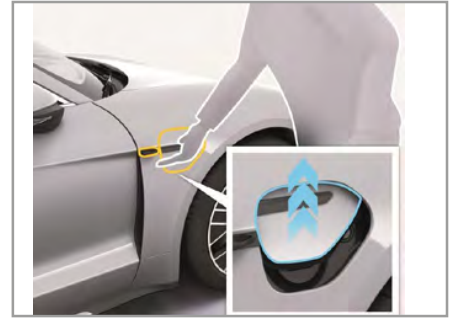

The Porsche Taycan is only available with an electric powertrain.

Taycan

The Porsche Taycan can be identified by the design of its body, the (optional) logo on the rear and the electrical symbols in the instrument cluster.

2. Shutdown / stabilisation / lifting

Press switch **P**.
This automatically activates the parking brake.



3. Avoidance of direct hazards / safety precautions

Switching off the ignition

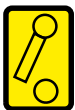

Press START-STOP without pressing the foot brake.



The absence of engine noise does not mean that the vehicle is switched off.



Re-starting is possible until the vehicle has been shut down.

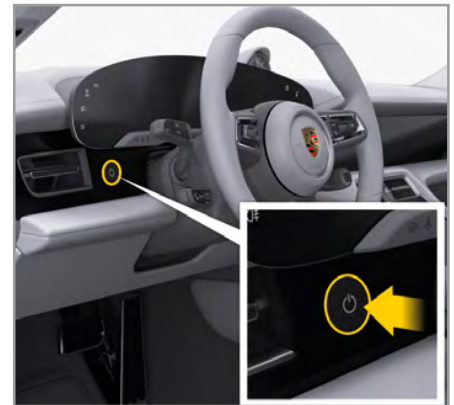

Deactivating the high-voltage system



The high-voltage system is automatically deactivated in the case of accidents where airbags and seat belt pretensioners have been triggered.



In all other cases, the high-voltage system must be deactivated as follows:



Deactivating the high-voltage system



Option 1 - Primary emergency disconnection point:
Remove the cover.

1. Release **A**-
2. and detach the service connector (marked with tab **B**) -a-.

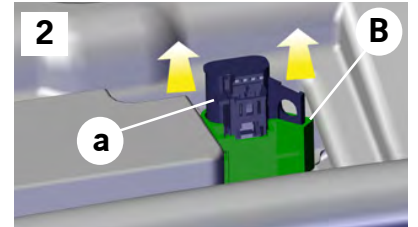
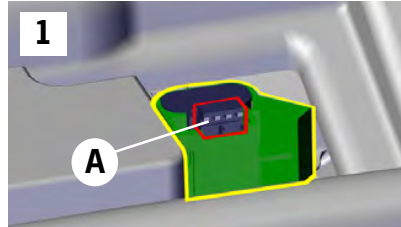
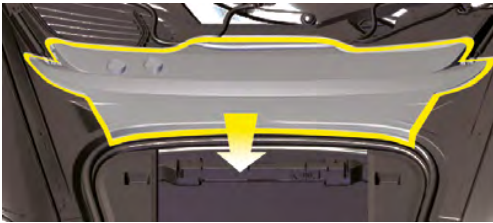
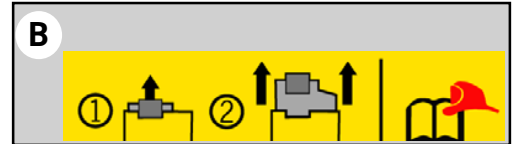

Option 2 - Secondary emergency disconnection point:

1. Remove the side cover on the right-hand side of the luggage compartment.
2. Remove the retaining frame (-**K**-) from the fuse block.
3. Detach fuse no. **1** (marked with tab **A**).

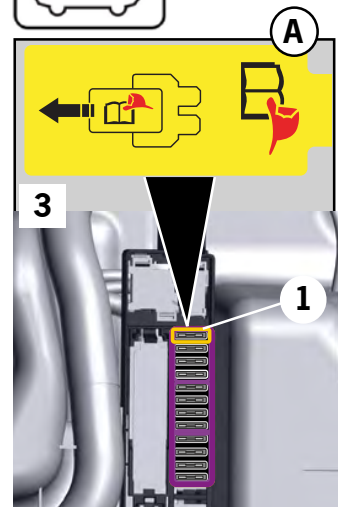
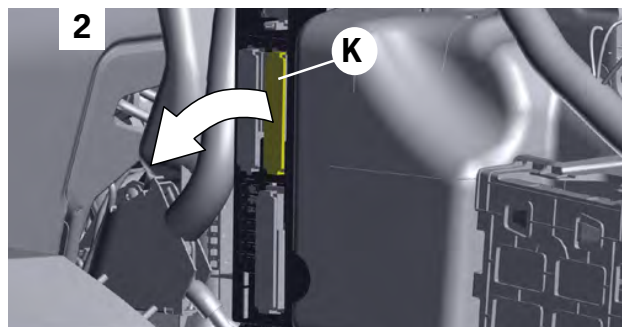

Wait around 20 seconds after switching off in order to ensure that no residual voltage is left in the high-voltage system.



The passive safety systems such as airbags and seat belt pretensioners continue to be provided with power by the 12-volt on-board power supply.

Disconnecting the 12-V battery

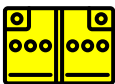

1. Remove the cover from the 12-volt battery at the rear right of the luggage compartment.
2. Unfasten the negative cable of the 12-volt battery at the screw connection and secure against accidental contact.



The passive safety systems (airbags and seat belt pretensioners) are deactivated.

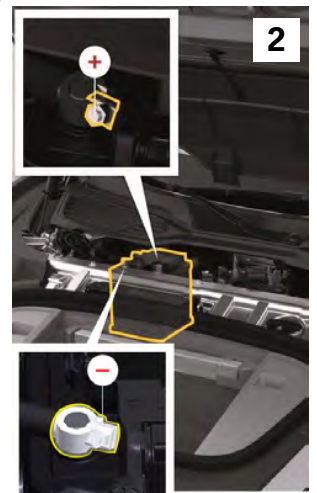

4. Accessing vehicle occupants

When freeing the occupants, attention must be paid to the parts of the bodywork made of high-strength steel and the components of the restraint systems (in particular pyrotechnic devices) as specified on Page 1.



It is essential to avoid additional deformation of the sill panels and the underbody during the rescue operation (e.g. use of hydraulic equipment to provide support).

5. Stored energy / liquids / gases / solids

LI ION



All high-voltage cables are provided with orange-coloured insulation.



NEVER cut, break or touch high-voltage components or cables. This could result in serious injuries or death.

6. Vehicle fires

Use large quantities of water (H₂O) to extinguish a vehicle fire.
Use an ample quantity of water (H₂O) to cool the Li-ion battery.



Warning: Re-ignition of the battery



7. Vehicle in water

There is no risk of voltage being applied to the bodywork.

After recovering the vehicle:

1. Allow the water to drain out of the inside of the vehicle.
2. Initiate deactivation of the high-voltage system (refer to Section 3).

8. Towing / transportation / storage

Only transport the vehicle with both axles on a recovery vehicle or car transporter.



Keep it at a safe distance from other vehicles.



Warning: Re-ignition of the battery



9. Important additional information

Further information on accident assistance and the recovery of vehicles with high-voltage systems can be found at <https://www.vda.de/en/services/Publications/rescue-and-towing-of-vehicles-with-high-voltage-systems.html>